



daisy.

COMMUNICATIONS

# | Daisy Hosted Voice

## Polycom VVX450 Full User Guide

---

**Daisy Communications Ltd**

Lindred House  
20 Lindred Road  
Brierfield, Nelson  
Lancashire BB9 5SR

**Contact us:**

**T:** 0800 040 8888  
**E:** [info@daisycomms.co.uk](mailto:info@daisycomms.co.uk)

The modern approach to  
**business communications**

[daisycomms.co.uk](http://daisycomms.co.uk)



# Table of Contents

<b>1</b>	<b><i>Introduction</i></b> .....	<b>4</b>
<b>2</b>	<b><i>How to set up the Polycom VVX450</i></b> .....	<b>5</b>
2.1	Phone Keys and Hardware.....	5
2.2	VVX450 Hardware Features and descriptions.....	6
<b>3</b>	<b><i>Phone Icons and Status Indicators</i></b> .....	<b>7</b>
<b>4</b>	<b><i>Calls Actions</i></b> .....	<b>8</b>
4.1	Place calls .....	8
4.2	Answer an incoming call.....	8
4.3	Hold a call .....	8
4.4	Resume a Call.....	9
4.5	Ending Calls.....	9
4.6	Transferring Calls .....	9
4.7	Transfer a Call .....	10
4.8	Cancel a Transfer .....	10
<b>5</b>	<b><i>Managing Calls</i></b> .....	<b>11</b>
5.1	Display Calls from the Lines Screen.....	11
5.2	Display Calls from the Calls Screen.....	11
5.3	Manage a Call from the Calls Screen.....	11
5.4	Reject Incoming Calls .....	12
5.5	Reject Calls from a Contact.....	12
5.6	Rejecting Calls with Do Not Disturb .....	12
5.7	Enable Do Not Disturb.....	12
5.8	Call Forwarding .....	13
<b>6</b>	<b><i>Audio Conference Calls</i></b> .....	<b>14</b>
6.1	Initiate a Conference Call .....	14
6.2	Join Calls to Create a Conference Call .....	14
6.3	End a Conference Call .....	15
6.4	Hold a Conference Call .....	15
6.5	Resume a Conference Call .....	15



6.6 Mute and Unmute Audio..... 15

7 *Phone Actions* ..... 16

7.1 View the Contact Directory ..... 16

7.2 Listen to Voicemail..... 16

8 *Enabling Wi-Fi functionality for the Polycom VVX450*..... 17



# 1 Introduction

## Polycom VVX450 Guide

This user guide will help you to navigate and use your VVX450 phone. It will give you an overview of your phone, and walk you through tasks so you can successfully use your phone to perform basic and advanced phone functions.





## 2 How to set up the Polycom VVX450

The phone will arrive pre-configured and needs to be connected to the internet & powered up using Power over Ethernet (PoE) or via AC power supply.

### 2.1 Phone Keys and Hardware



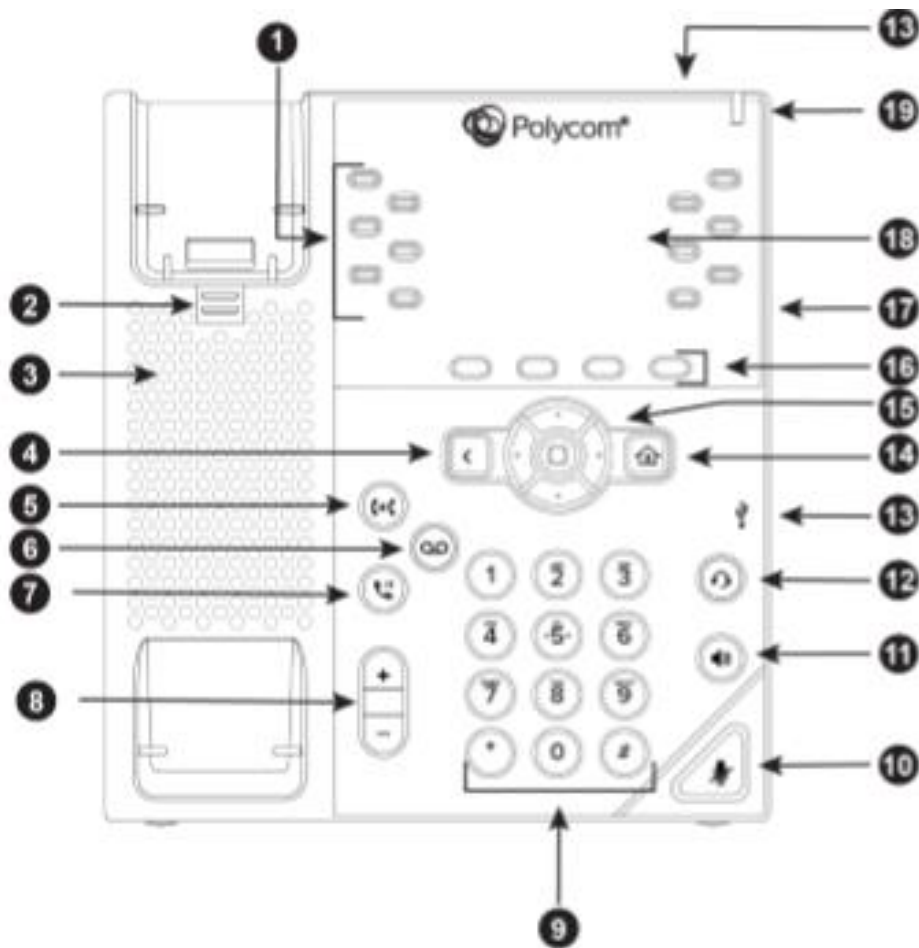



















The figure below shows the main phone keys and features.



## 2.2 VVX450 Hardware Features and descriptions

Reference Number	Feature	Feature Descriptions
1	Line keys	Enable you to select a phone line, view calls on a line, or quickly call a favourite contact.
2	Reversible tab	Secures the handset in the cradle when your phone stand is positioned at a high angle. To secure the handset, remove the tab, reverse it so the protrusion points up, and re-insert it. Position the handset so the protrusion on the tab fits into the slot on the handset.
3	Speaker	Provides ringer and speakerphone audio output.
4	Back key	Enables you to return to the previous screen.
5	Transfer key	Transfers an active call to a contact.
6	Messages Key	Enables you to access and manage instant and voice messages.
7	Hold key	Holds an active call or resumes a held call.
8	Volume keys	Adjust the volume of the handset, headset, speaker, and ringer.
9	Dial pad	Enables you to enter numbers, letters, and special characters. You can also use the dial pad keys to select menu items that have index numbers.
10	Mute key	Mutes local audio during calls and conferences.
11	Speakerphone key	Enables you to place and receive calls using the speakerphone.
12	Headset key	Enables you to place and receive calls through a headset.
13	USB Port	Enables you to attach a USB flash drive or USB headset.
14	Home key	Displays the Home screen from other screens and displays the Lines and Calls screen from the Home screen.
15	Navigation keys / Select key	Scrolls through information or options displayed on the phone's screen. Selects a field of displayed data.
16	Soft keys	Enable you to select context sensitive keys that display along the bottom of the screen.
17	Security slot (on back)	Enables you to attach a universal security cable lock to your phone so you can secure it to a desktop.
18	Screen	Shows a 10.9 cm (4.3 in) colour display with a backlight that enables you to view menu options and data.
19	Message Waiting Indicator	Flashes red to indicate when you have new messages.

### 3 Phone Icons and Status Indicators



Icon	Meaning	Icon	Meaning
	Registered line		Phone warning
	Unregistered line		Login credentials invalid
	Outgoing call		Shared line
	Held call		Call forwarding enabled
	Incoming call		Presence status (Available)
	Active conference		Presence status (Busy or In a Call)
	Do Not Disturb enabled		Presence status (Away)
	Favourite		Presence status (Do Not Disturb)
	Placed call		Presence status (Offline)
	Received call		New message
	Missed call		Wireless network

## 4 Calls Actions

### 4.1 Place calls



The VVX 450 phone can manage a maximum of three active, incoming, and held audio calls at a time. However, you can have only one active call in progress with numerous other incoming calls or calls on hold on all phones.

#### Procedure

1. Do one of the following:
  - Start typing a phone number.
  - Select **New Call**.
  - Press a line key.
  - Pick up the handset, press , or press .
2. Enter a number or select a recent contact.
3. Select **Dial**.

### 4.2 Answer an incoming call

#### Procedure

1. Do one of the following:
  - Pick up the handset.
  - Press  or select **Answer**.
  - Press .

After you answer the incoming call, the call becomes active.

### 4.3 Hold a call

You can place any active call on hold on VVX 450 Phone

#### Procedure

During an active call, select **Hold**   
If you're in the Calls screen, select the call first.



- A hold icon  is displayed on the line of the held call and a red LED light flashes on the line key.

## 4.4 Resume a Call

You can view and resume all held calls on the phone.

Do one of the following -

- Select **Resume**.
- From the Calls screen, select the call and select **Resume**.

## 4.5 Ending Calls

You can end active calls at any time, however, you must resume held calls before you can end the call.

You can end an active call on your phone at any time.

1. Do one of the following
  - Place the handset on the cradle.
  - Press **End Call**.
  - In the Calls screen, highlight the call and press **End Call**

## 4.6 Transferring Calls

You can transfer active or held calls to another person using the following transfer types:

- Blind transfer—Transfers the call directly to another line without speaking with the other party first.
- Consultative transfer—Enables you to speak with the other party before completing the transfer.

### Choose a Default Transfer Type

You can choose a default transfer type to use for all calls on VVX 450 phone.

When you choose a default transfer type, the phone uses the selected transfer type for all calls.

Consultative is the default transfer type.

### Procedure

1. Navigate to Settings > Basic > Preferences.
2. Select Default Transfer Type and choose a transfer type.



The selected transfer type is used for all calls.

## 4.7 Transfer a Call

You can transfer a call to another contact and choose the transfer type you want to use for the call.

### Procedure

1. During a call, do one of the following

- Press **Transfer**  to use the default transfer type.
- Press and hold **Transfer**  to use the non-default transfer type.

For example, if Blind is the default, press and hold **Transfer**  to perform a Consultative transfer.

- Press **Transfer**  > More and select Blind or Consultative.

Depending on the default transfer type, either the Blind or Consultative option displays. For example, if the default transfer type is Blind, then you can select Consultative.

2. Dial a number or choose a contact from the Recent Calls or a directory.

If the transfer type is set to Blind, the call is transferred immediately.

3. If the transfer type is set to Consultative, select **Transfer**  after speaking with your contact.

## 4.8 Cancel a Transfer

If a contact does not answer the transfer or you want to remain speaking with the contact on your line, you can cancel the transfer before it is complete.

### Procedure

- Select **Cancel**.

The call is not transferred and becomes active.

## 5 Managing Calls

### 5.1 Display Calls from the Lines Screen

You can display the calls for each line from the Lines screen. When you select a phone line that has a held call, the first held call on that line is automatically resumed, even if you already have an active call on a different line.

#### Procedure

- Press and hold the **line** key 

### 5.2 Display Calls from the Calls Screen

You can view multiple calls on your line from the Calls screen.

#### Procedure

1. Do one of the following:

- Press the Home key 
- From the Lines screen, press the **Calls** soft key.

The Calls screen is displayed with the list of active and held calls for each line on the phone.



### 5.3 Manage a Call from the Calls Screen

From the Calls screen, you can manage a call by holding, resuming, or transferring the call.

#### Procedure

1. Select a call.

2. Do one of the following:

- Select **Hold**  to place an active call on hold.
- Select **Resume** to make a held call active.
- Select **End Call** to end a call with a contact. You can end active calls only, so resume the held call first before ending it.
- Select **Transfer**  to send the call to another contact.

- Select **Conference** to initiate a conference call.

## 5.4 Reject Incoming Calls

You can reject a call and send the call directly to voicemail. Rejected calls display in the Missed Calls list in your Recent Calls list. Rejecting calls is not available for shared lines.

### Procedure

1. From the Incoming Call screen, select **Reject**.

## 5.5 Reject Calls from a Contact

You can send incoming calls from a particular contact directly to your voicemail.

### Procedure

1. Navigate to **Directories > Contact Directory**.
2. From your Contact Directory, select a contact.
3. From the Contact Information screen, select Edit or tap.
4. From the Edit Contact screen, select Auto Reject > Enabled and select Save.

Calls from the contact are sent directly to voicemail when the contact calls

## 5.6 Rejecting Calls with Do Not Disturb

Do Not Disturb (DND) enables you to set your phone to automatically reject calls when you don't want to be interrupted.

## 5.7 Enable Do Not Disturb

You can enable DND to prevent your phone from ringing and to send all incoming calls directly to voicemail. All calls you receive while DND is enabled are logged in the Recent Calls list.

Enabling DND on shared lines disables ringing only. A visual notification of the call still displays, and you have the option to answer or ignore the call.

Note: When you set your presence status to Do Not Disturb and enable DND on your phone, a message stating that your status is set to Do Not Disturb scrolls under the time display, and the DND icon does not display in the status bar.

## Procedure

1. Select **DND**

## 5.8 Call Forwarding

You can forward an incoming call to a contact or forward all incoming calls to a contact.

To forward an incoming call:

1. In the Incoming Call screen, select **Forward**.
2. From the Call Forwarding screen, enter the forwarding number, and select **Forward**.

To forward all incoming calls:

1. Select **Forward** or navigate to **Settings > Features > Forward**.
2. If your phone has multiple lines, select a line.
3. On the **Forwarding Type Select** screen, select a forwarding type.
4. Enter a contact's number if enabled, and select **Enable**.

If you selected the No Answer option, enter the number of rings before the call is forwarded.

To disable call forwarding:

1. Select **Forward**.
2. If your phone has multiple lines, select a line.
3. From the **Forwarding Type Select** screen, select your forwarding type, and select **Disable**.

## 6 Audio Conference Calls

The VVX450 phone can manage a maximum of three active or held conference calls at a time. However, you can have only one active conference call in progress with numerous other conference calls on hold.

### 6.1 Initiate a Conference Call

You can initiate a conference call with up to two contacts.

Note: When your phone is set up for single key press conferences, you do not need to select the Conference soft key a second time to join parties to a conference call.

#### Procedure

1. Call a contact.
2. When the contact answers, select the **Conference** soft key.

The call is held.

3. Enter another contact's number or select a contact from the directory or the call lists.
4. When the contact answers, select the **Conference** soft key.

All call participants are added to a conference call.

### 6.2 Join Calls to Create a Conference Call

You can join one active call and one held call into a conference call.

#### Procedure

1. Do one of the following
  - When you have an active call and a held call, select the **Join** soft key.
  - When you have an active call and more than one held call, select a held call and then select the **Join** soft key.

The active call and the selected held call are joined into a conference. If you have multiple held calls, the other held calls on the line remain held.

## 6.3 End a Conference Call

When you end a conference call, your connection to the call and all other participants will end

### Procedure

1. During a conference call, select **End Call**.

## 6.4 Hold a Conference Call

When you place a conference call on hold, you place all conference participants on hold.

### Procedure

1. Select **Hold** 

## 6.5 Resume a Conference Call

Resuming a held conference call enables all participants to hear the audio of everyone on the call.

### Procedure

1. Select **Resume**.

## 6.6 Mute and Unmute Audio

You can mute the microphone so other parties cannot hear you. Microphone Mute applies to the handset, headset, and speakerphone. You can still hear all other parties when you mute your microphone.

### Procedure

- 1. During a call, including a conference call, press the mute key 
- The other parties cannot hear you.
- 2. Press again to unmute the microphone.

## 7 Phone Actions

### 7.1 View the Contact Directory

You can view and add contacts to the Contact Directory. To view the Contact Directory:

- From the Home screen, **Directories > Contact Directory**.

### 7.2 Listen to Voicemail

#### Procedure

1. Navigate to **Messages**.
2. Select **Message Center**.
3. If you have multiple lines on your phone, select the line that has the new message.
4. From the Messages screen, select **Connect** and follow the prompts to access your messages.



## 8 Enabling Wi-Fi functionality for the Polycom VVX450

By default, the Polycom VVX450 is configured to connect via a wired connection. To enable the Wi-Fi functionality a USB Wi-Fi dongle needs to be connected to the device and the Wi-Fi option needs to be enabled from within the menu.

Start by inserting the USB Wi-Fi dongle into the USB port on the rear of the device. The Wi-Fi mode then needs to be enabled.

This can be done by following the below menu sequence:

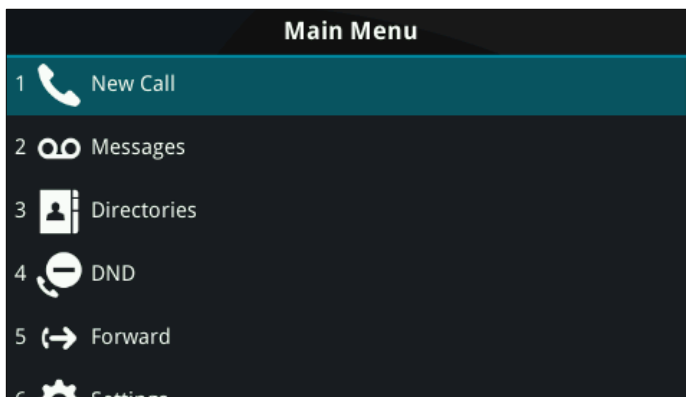

Entering the Main Menu and navigating down to option 7 “Wi-Fi”



Entering the “Wi-Fi” menu option will present the current status, which as default will be “Off”

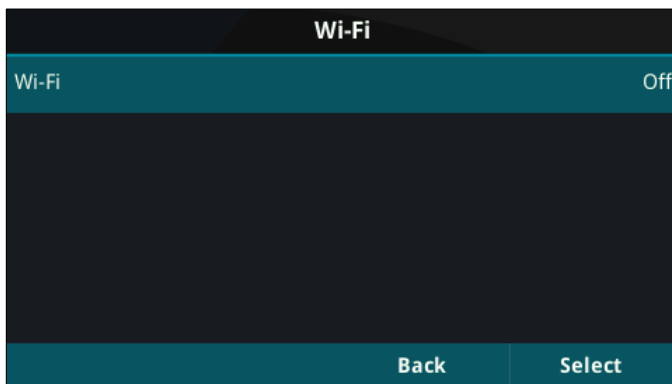

To enable this functionality, navigate down to “On” and press the “Select” key

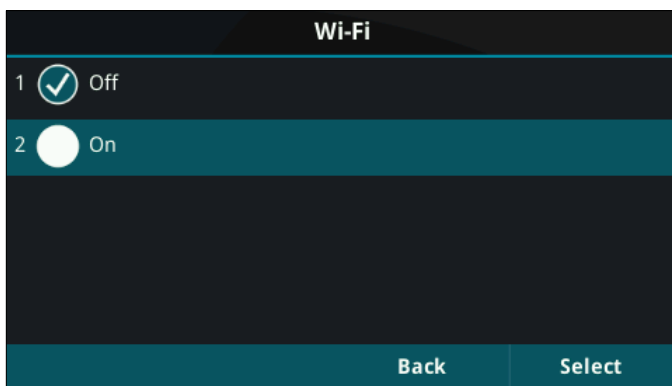

Once this is selected, the phone will advise you that it requires a reboot, select “Cancel” to go back or “Yes” to continue with the reboot.

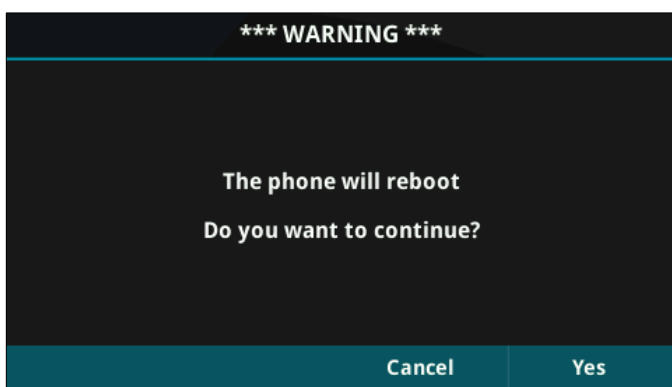

It's important to note that when the device boots up, it will no longer be able to obtain an IP address via the wired connection (Both Wired and Wireless cannot run in parallel)



Once the device has started the above prompt will be displayed on screen, press “Start” to begin the setup.

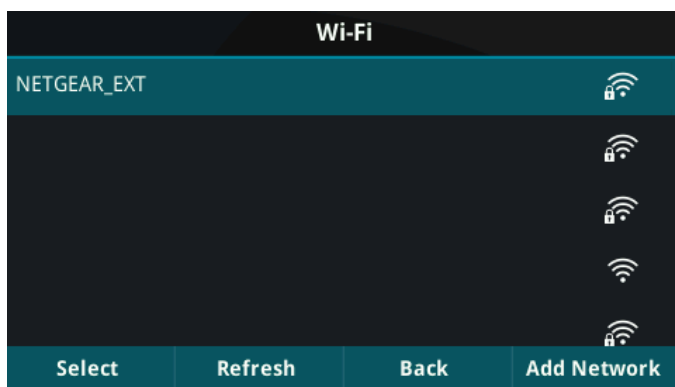

The ability to scan for a Wi-Fi network is presented. A list of available networks will populate this page and from here you can press “Select” to attempt to join that network.

Upon pressing “Select” you will need to enter the appropriate security credentials for that particular Wi-Fi network. Once you have finished press the “More” option and then press “Connect”

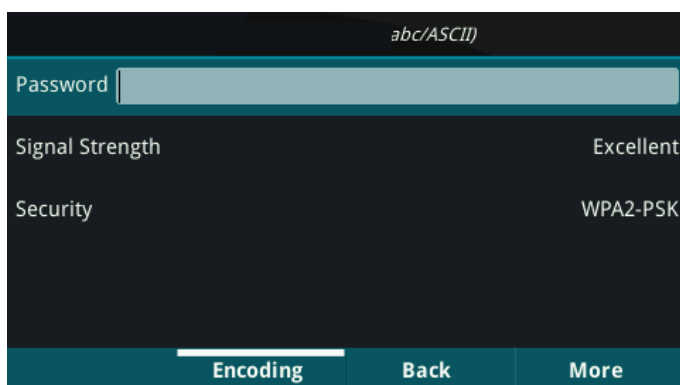

The device will then join the chosen Wi-Fi network.

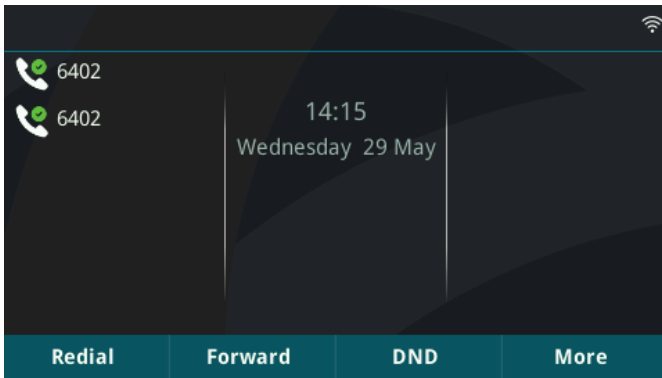

A visual indicator is present at the top right corner of the display.